

CH-1751 3/4 x 1-3/4

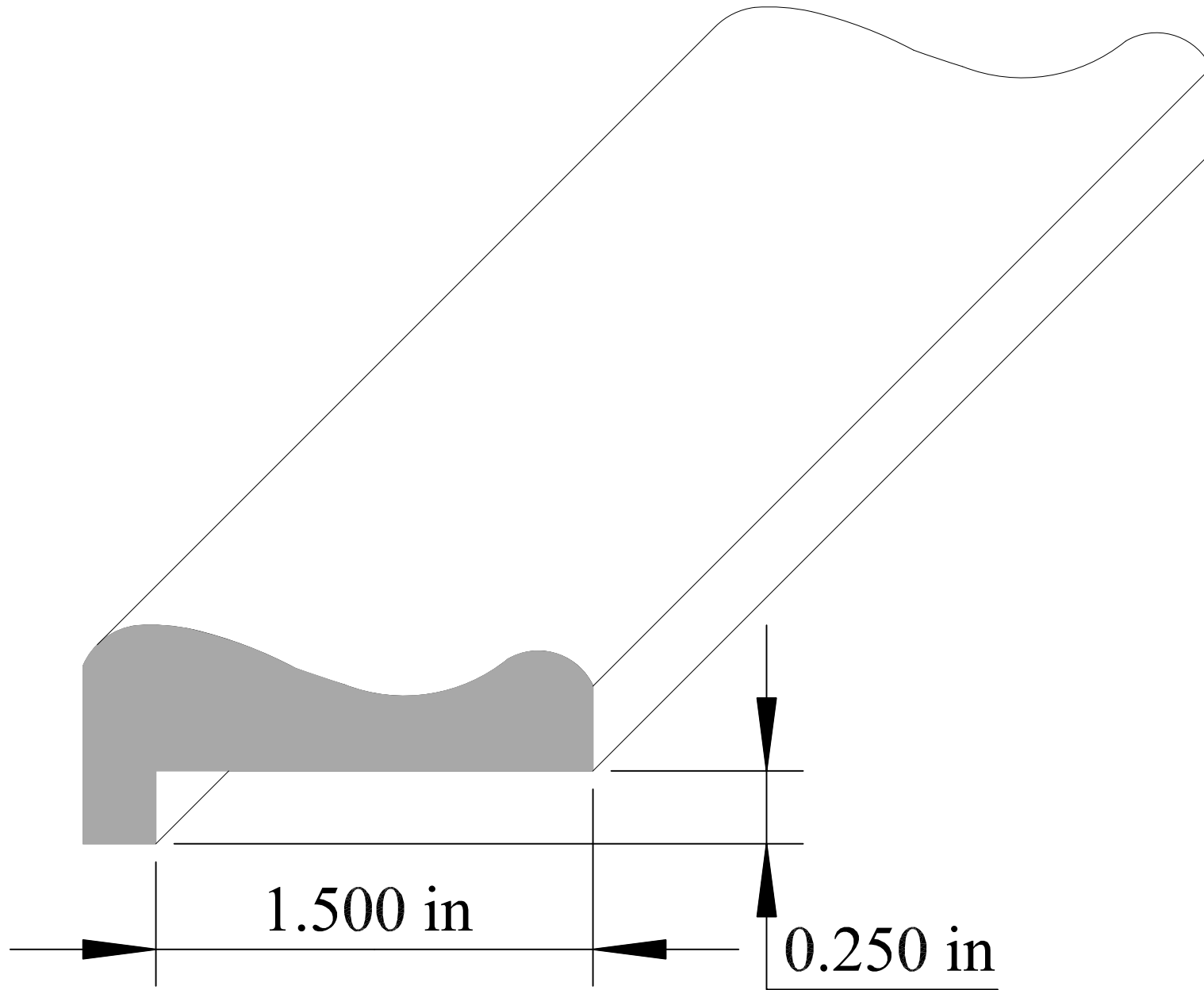

CH 2254 $3/4$ x 2 $1/4$

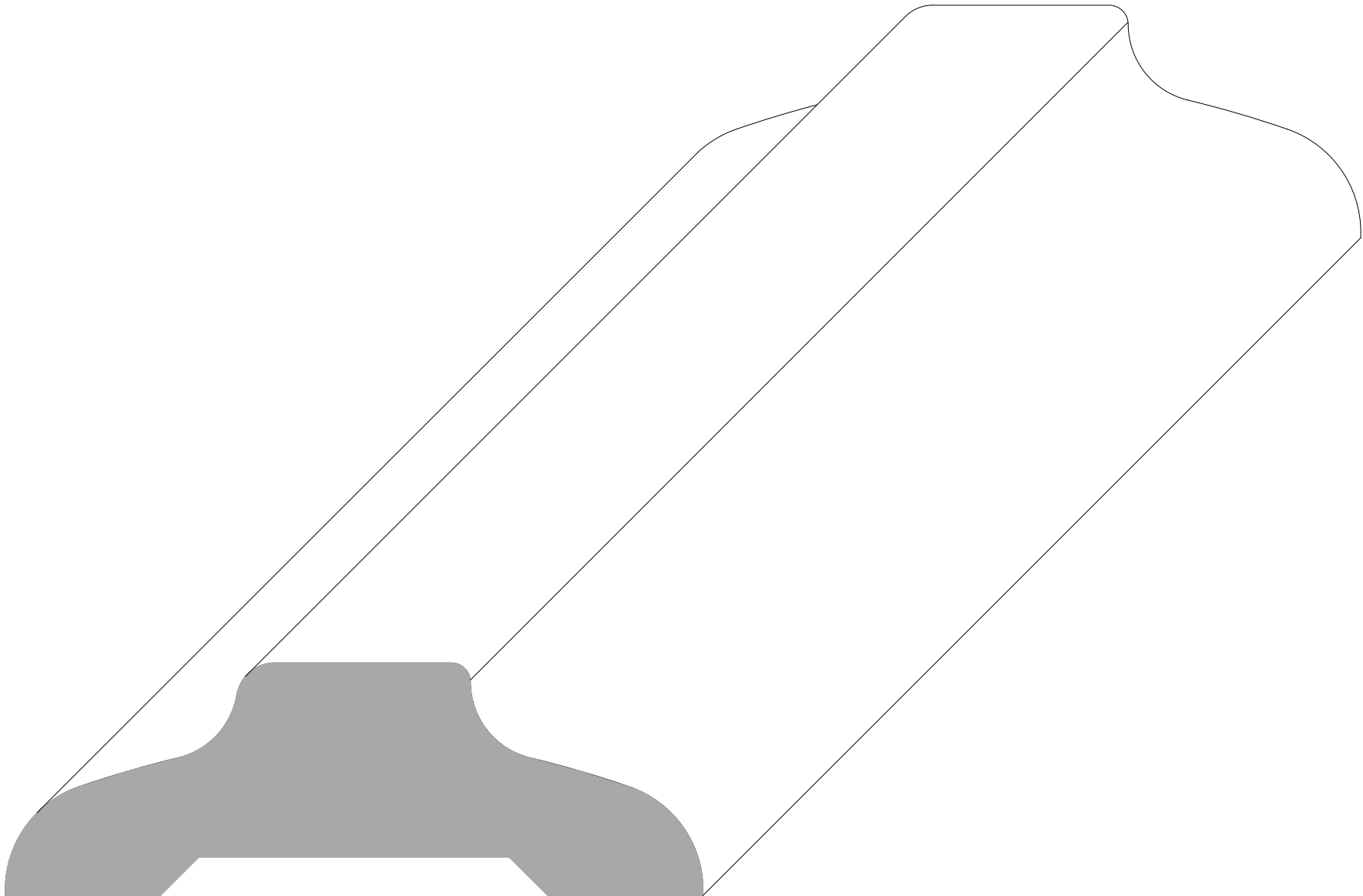

CH 2437 13/16 x 2 7/16

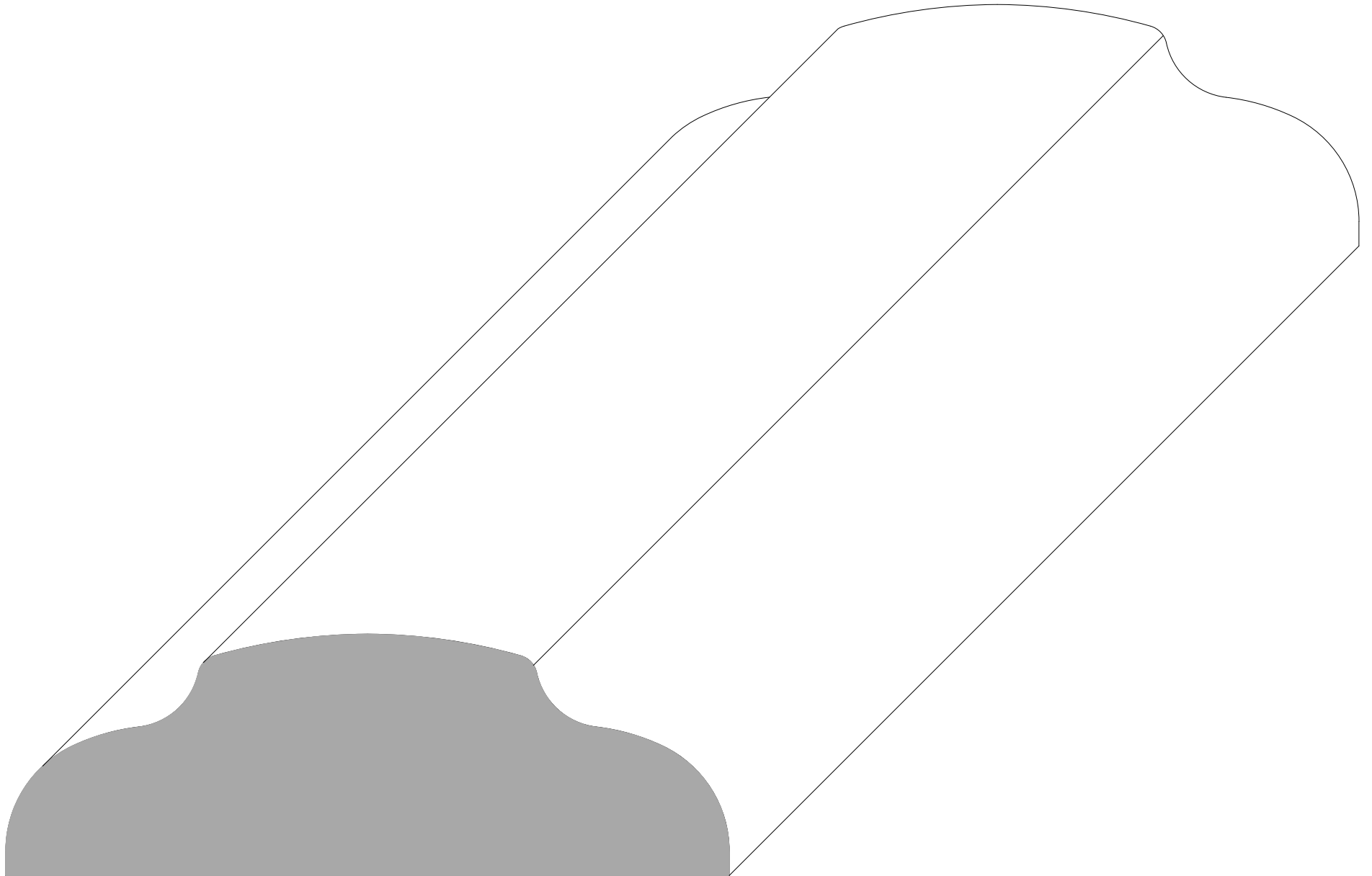

CH 2501 1 X 2 1/2

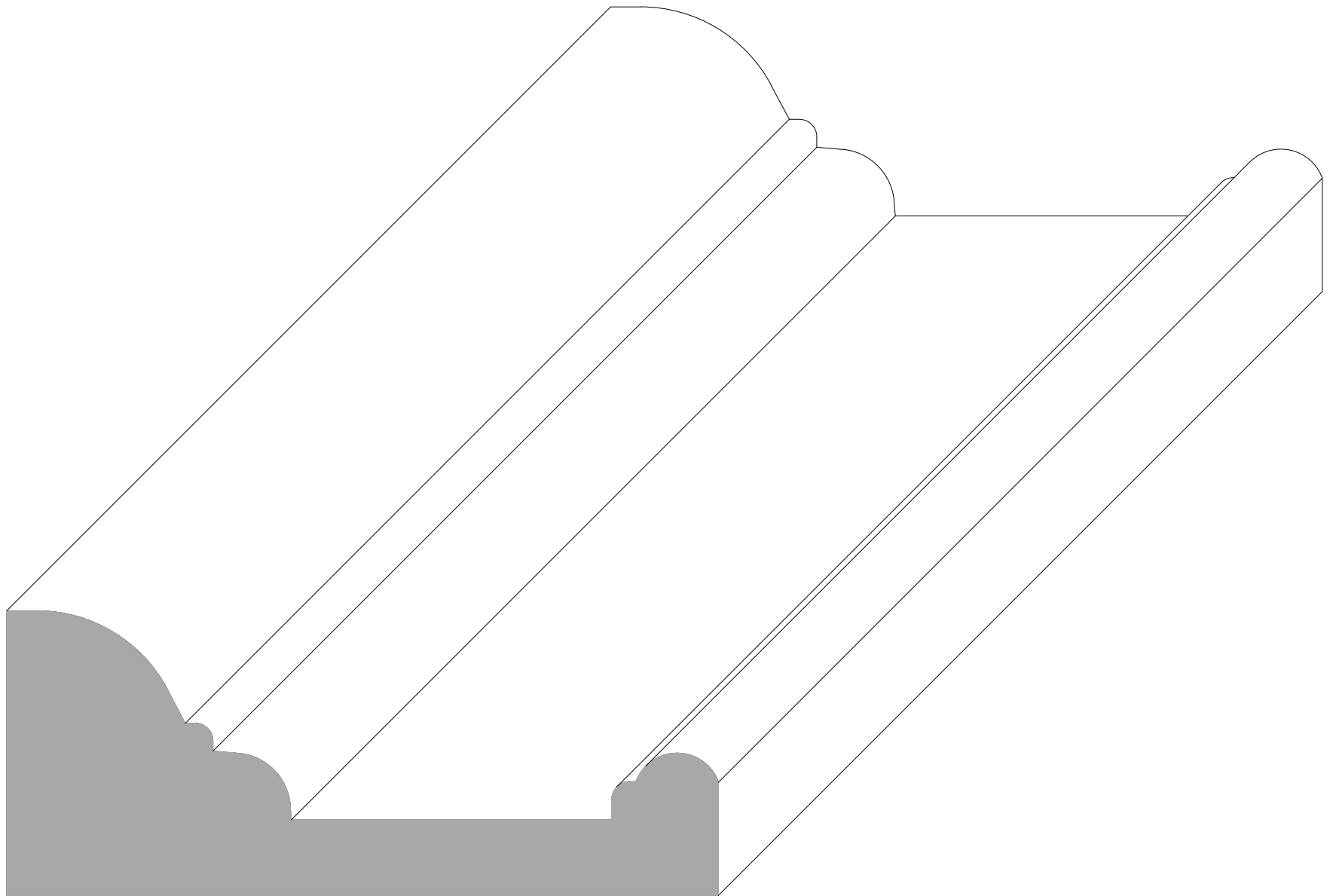

CH 2504 5/8 x 2 1/2

Overall width is adjustable.

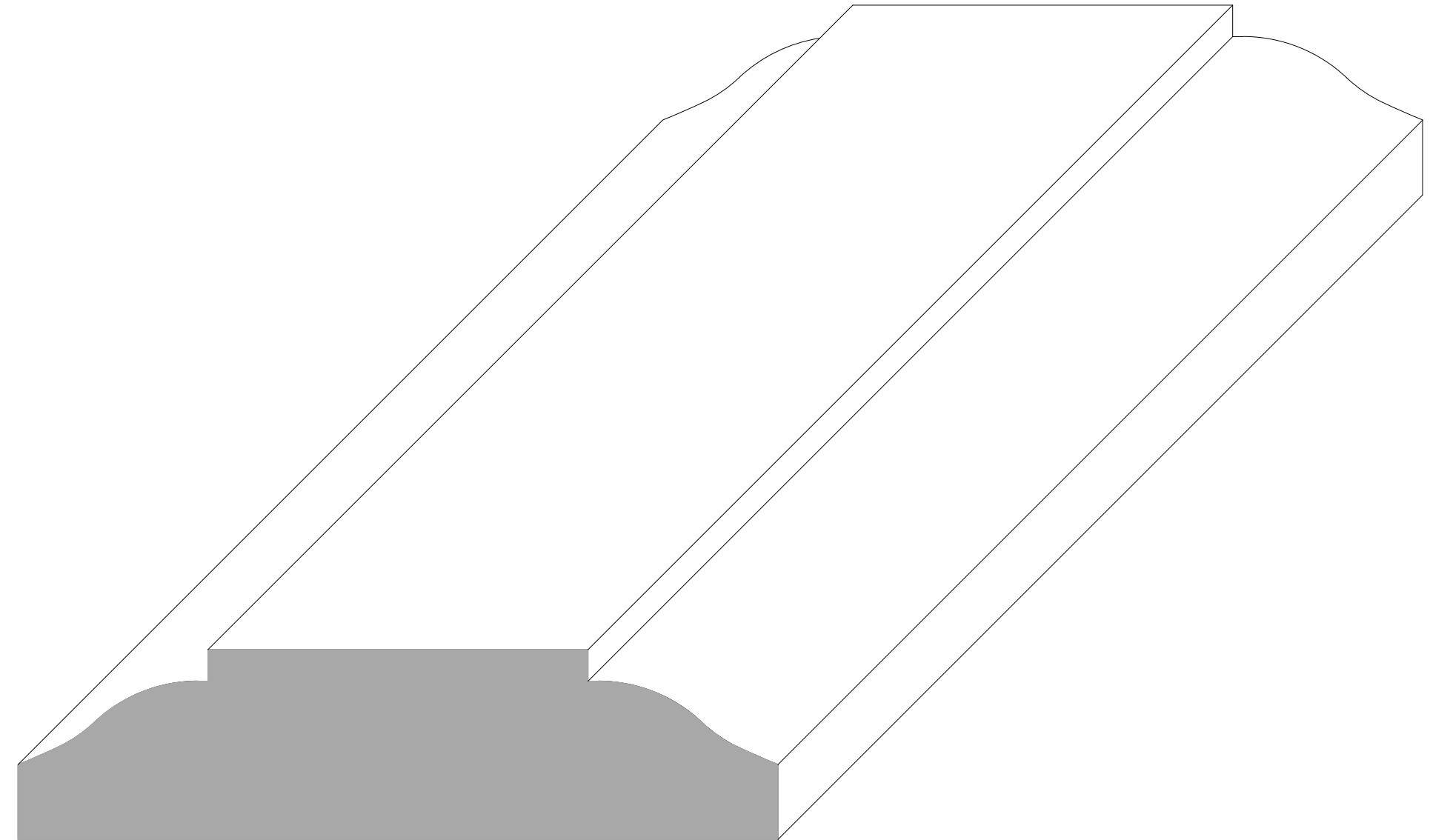

CH 2505 3/4 x 2 1/2

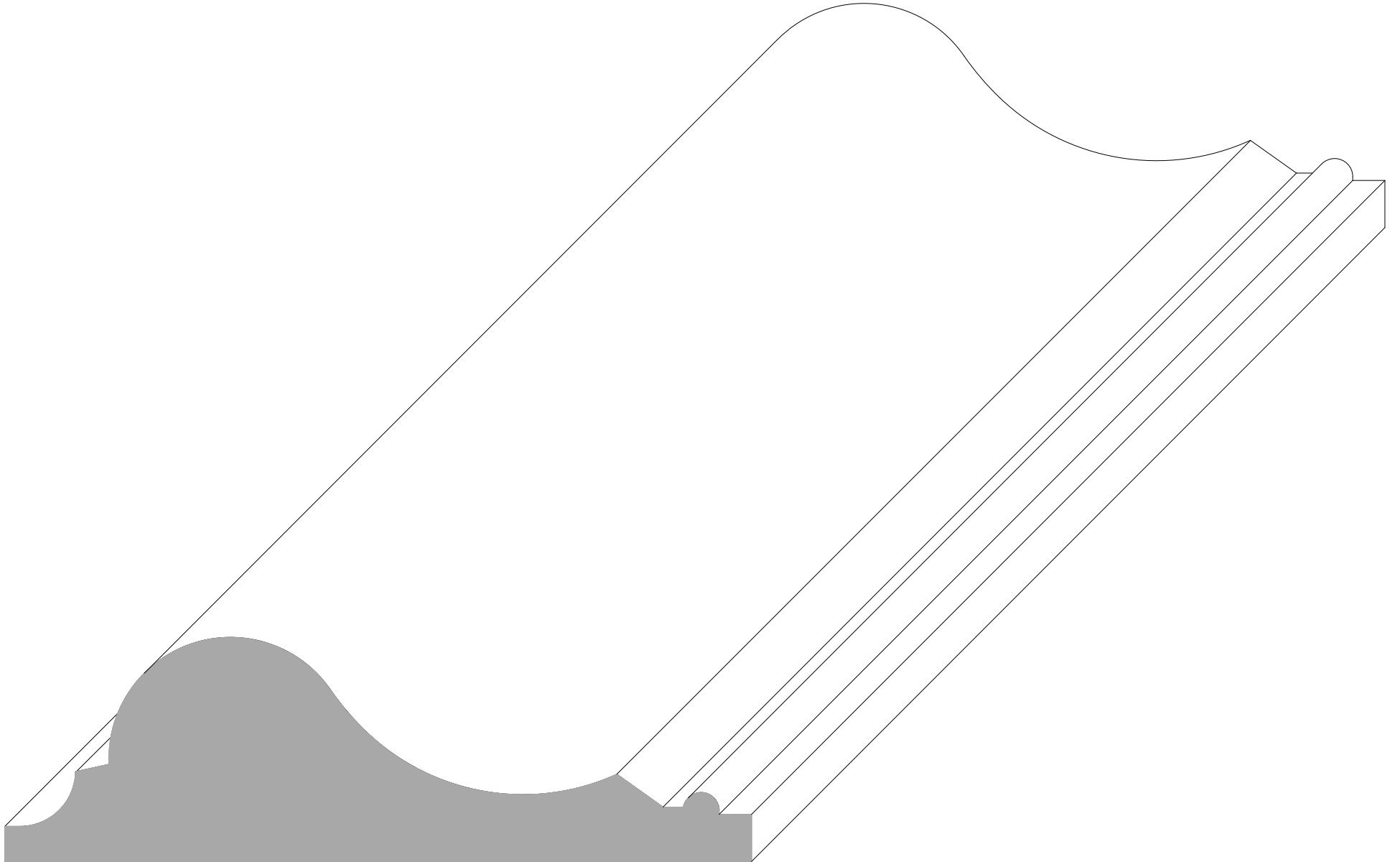

CH 2751 3/4 X 2-3/4

.375 x 1.586 INLAY

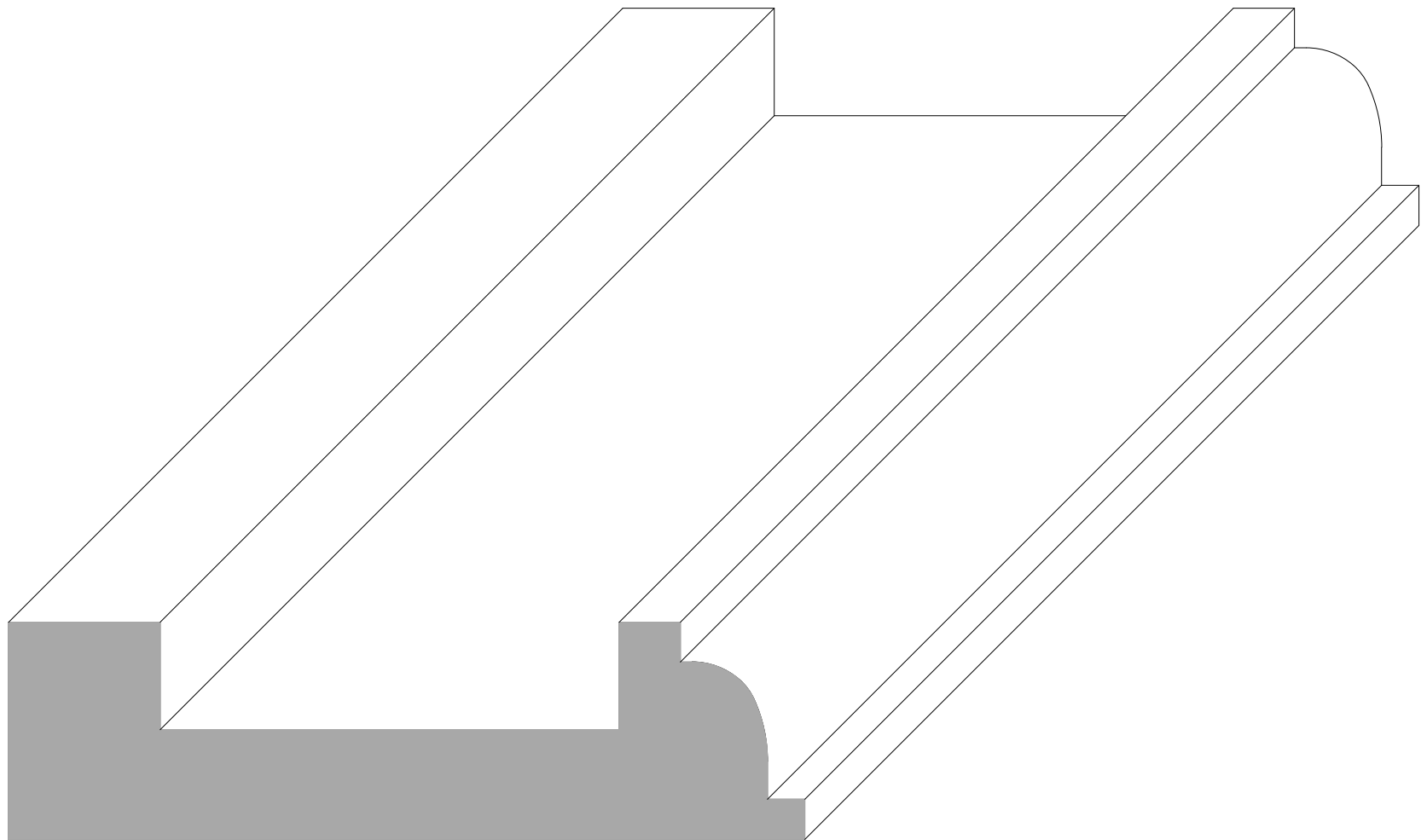

CH 2937 11/16 x 2 15/16

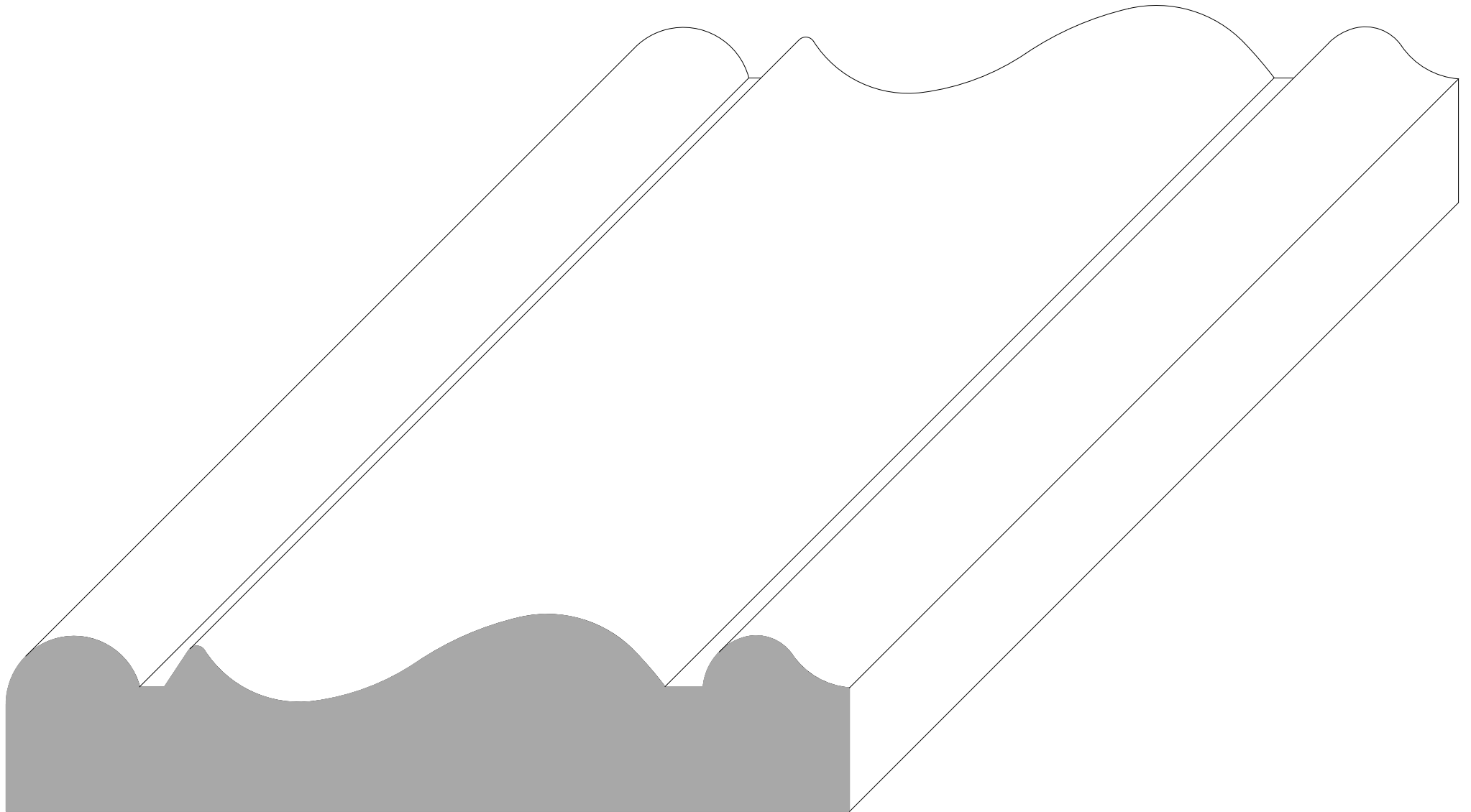

CH 3002 9/16 x 3

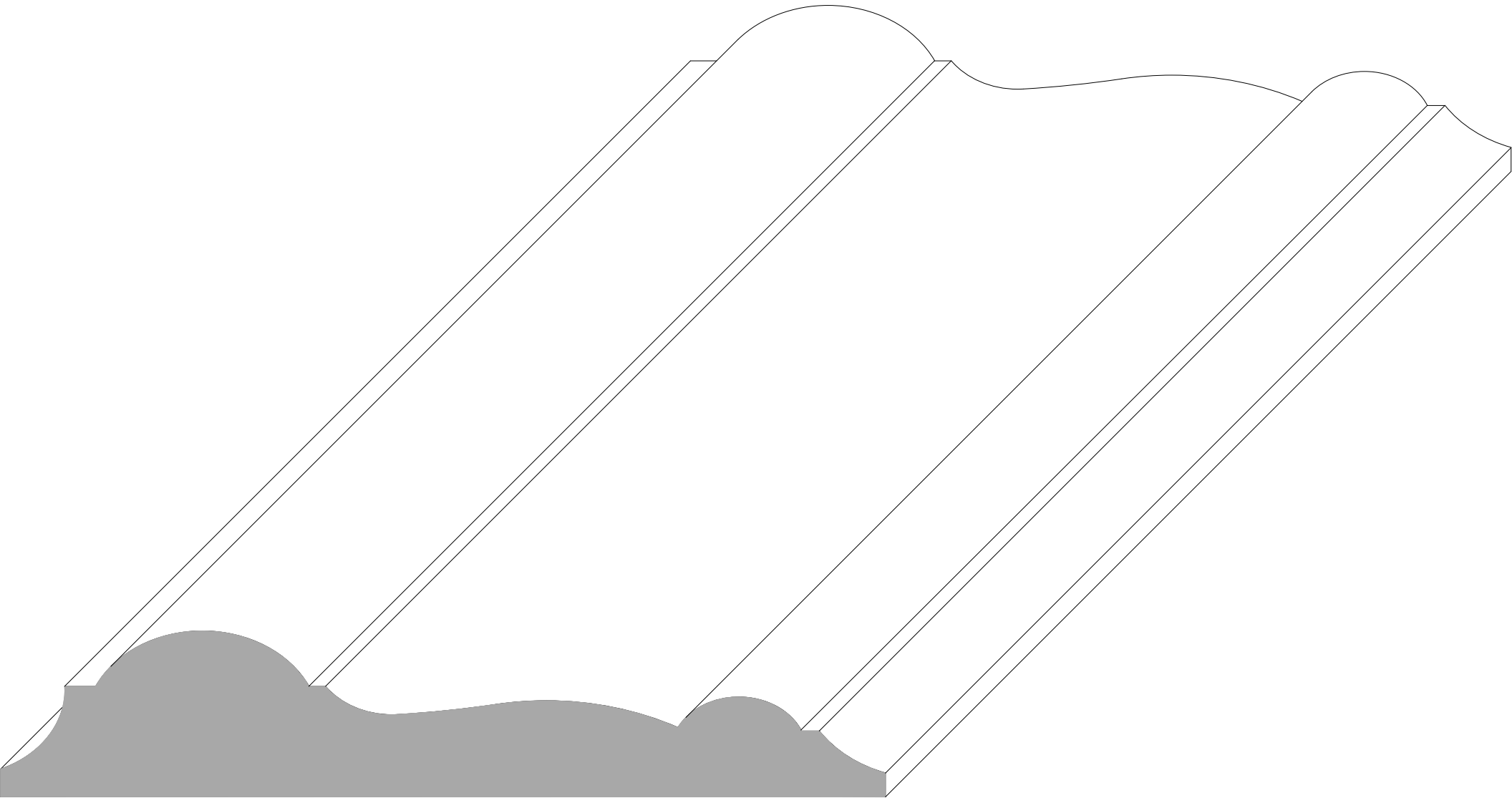

CH 3003 9/16 x 3

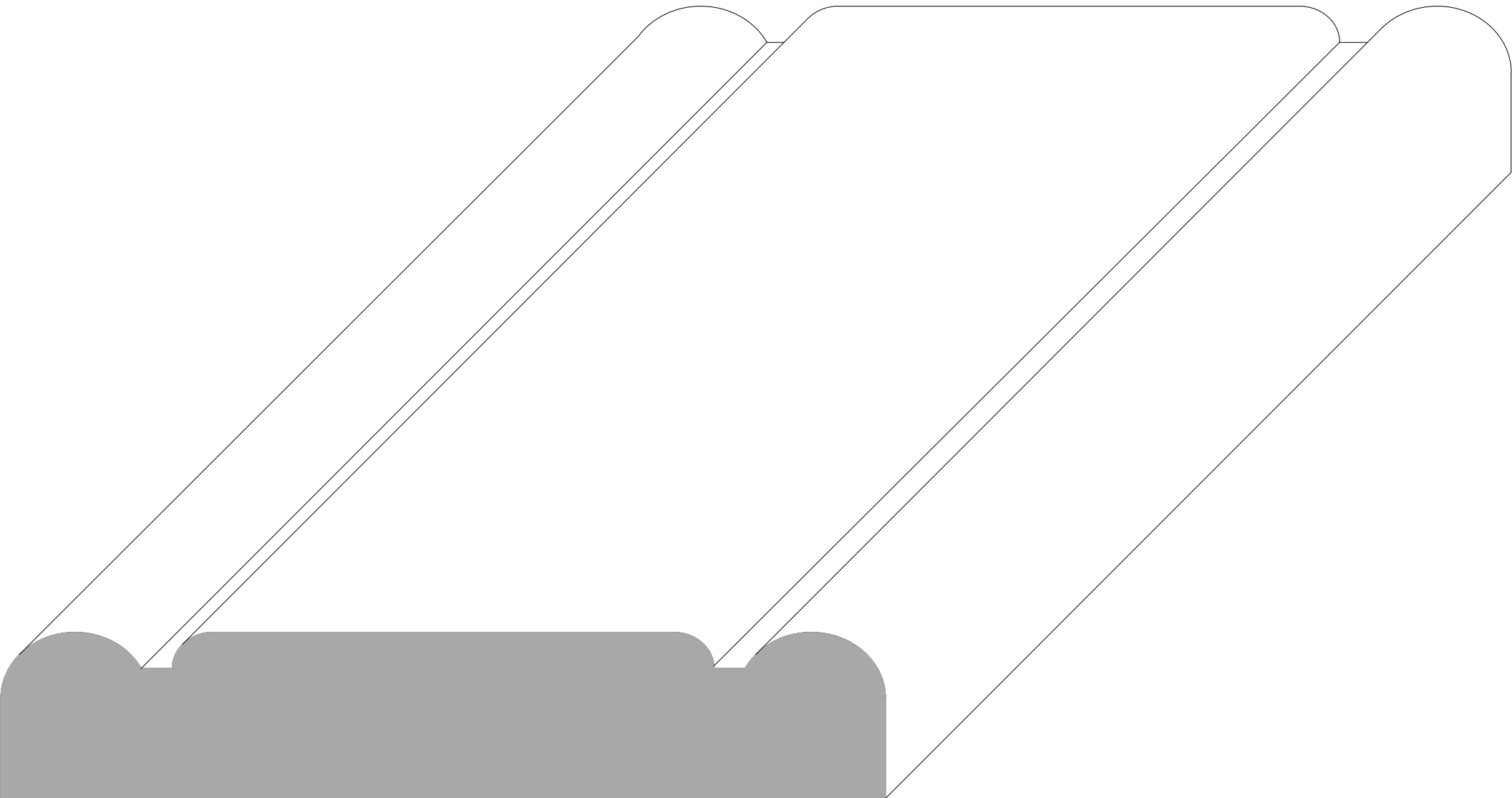

CH 3253 1/2 x 3 1/4

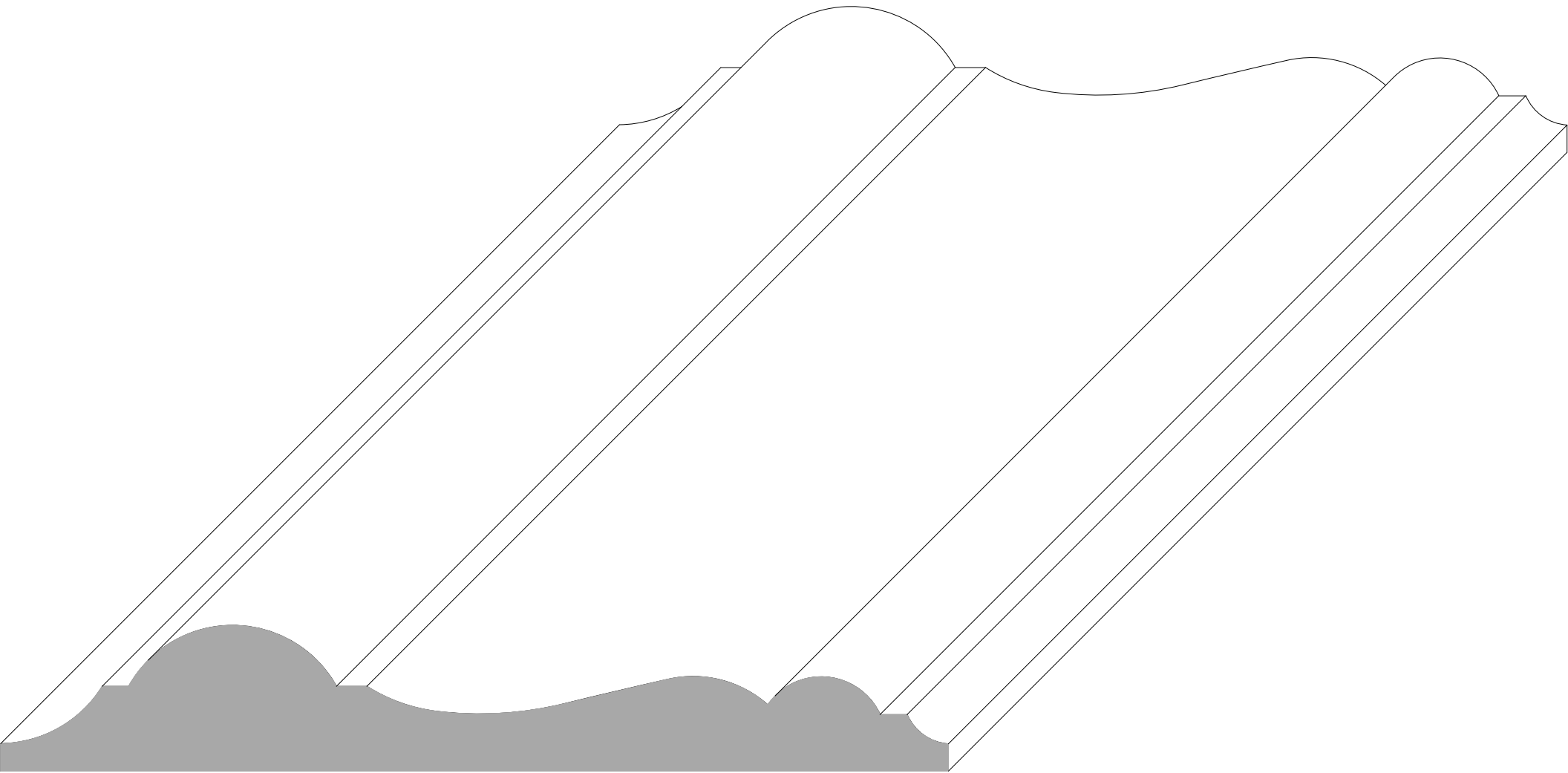

CH 3255 $3/4$ x 3 $1/4$

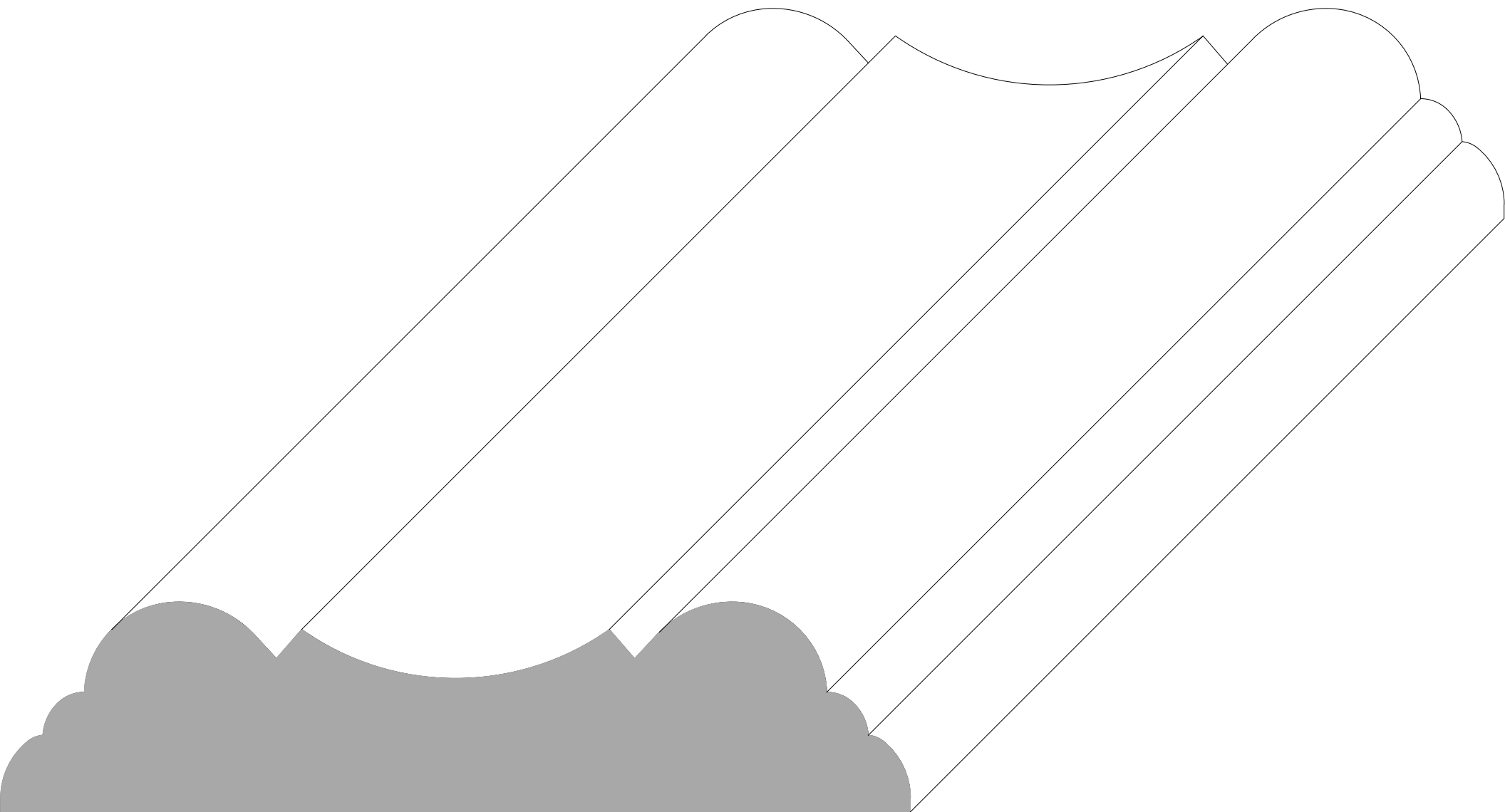

CH 3375 1/2 x 3-3/8

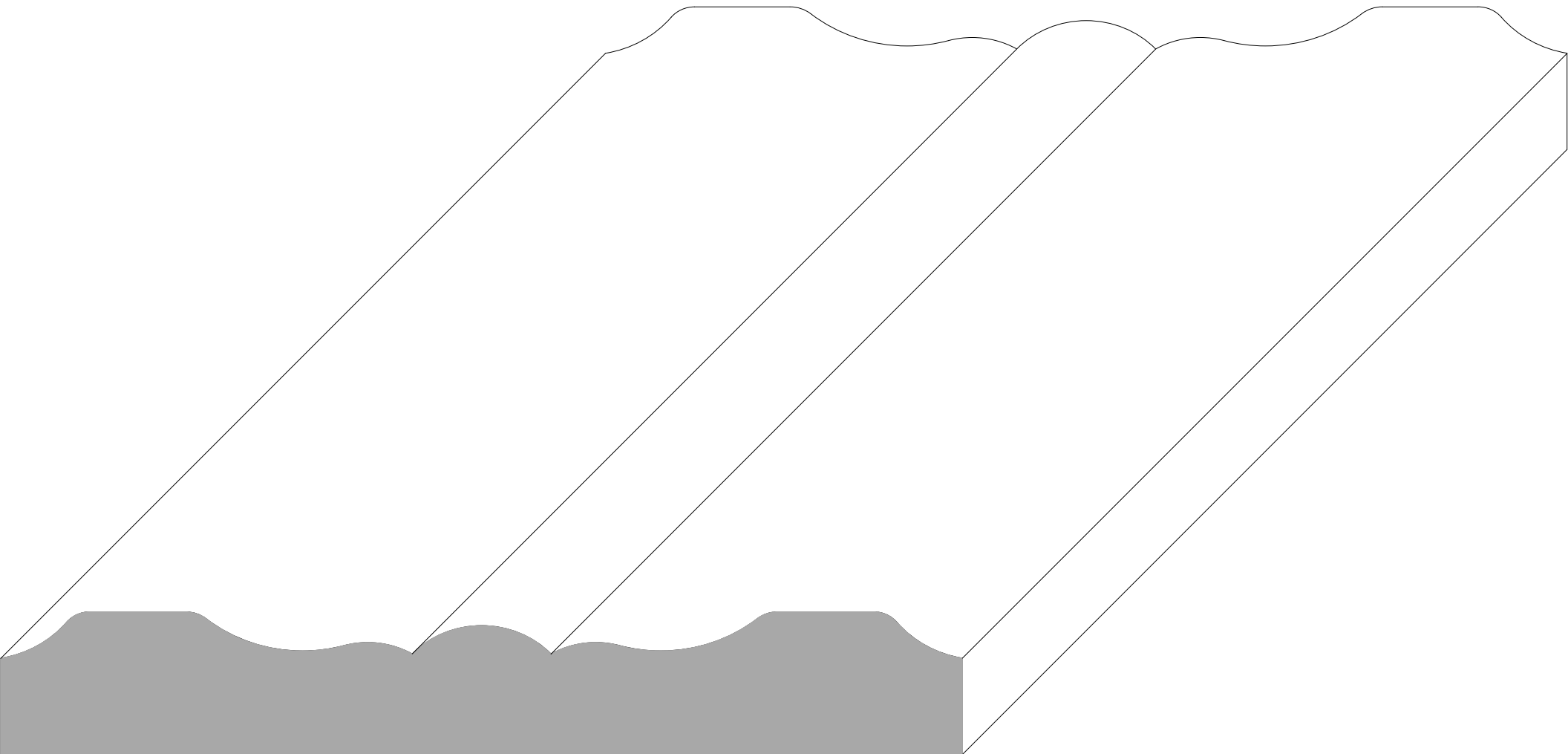

CH 3482 .800 x 3.482

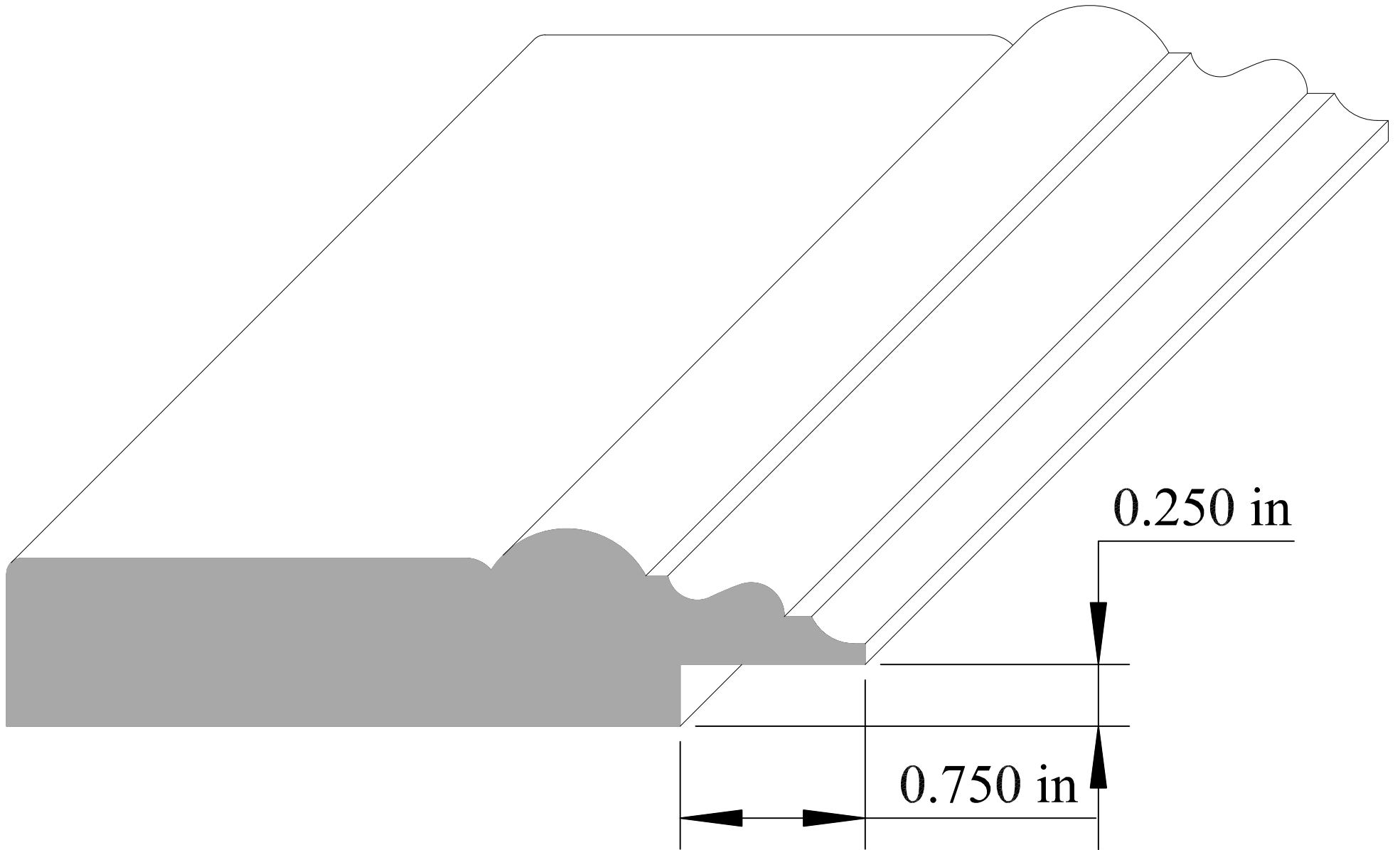

CH 3500 5/8 X 3-1/2

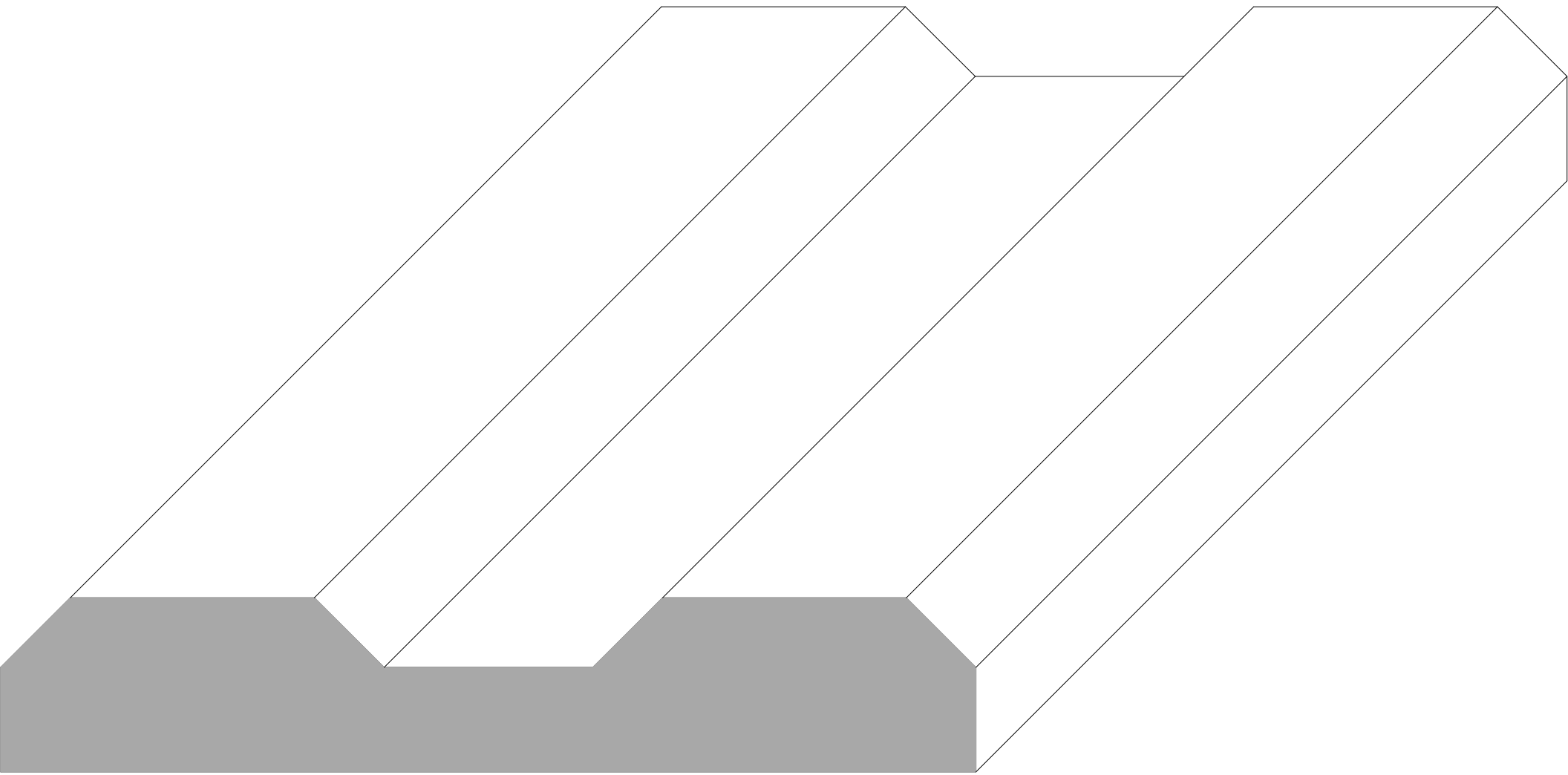

CH 3509 3/4 x 3-1/2

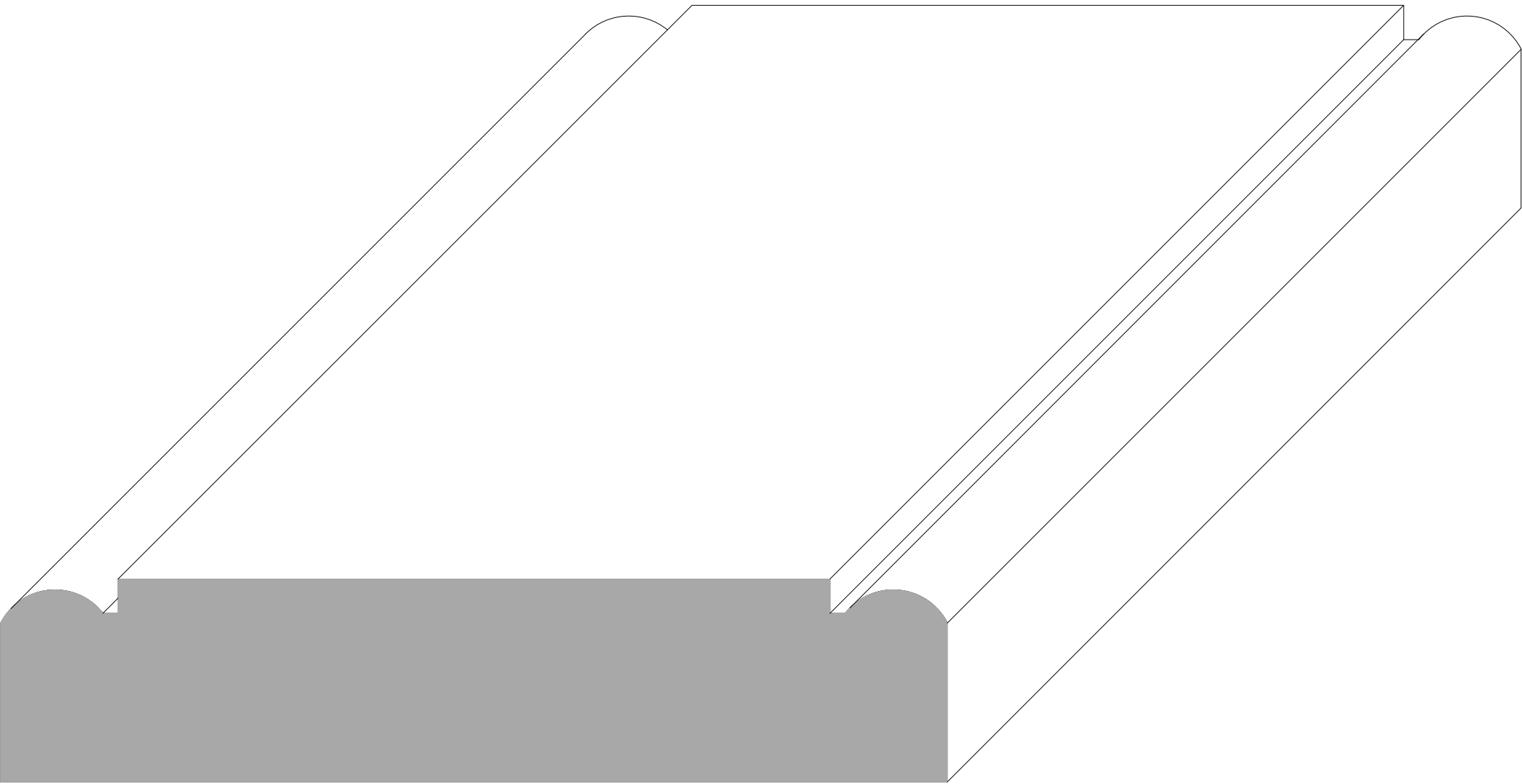

CH 3625 1 5/16 x 3 5/8

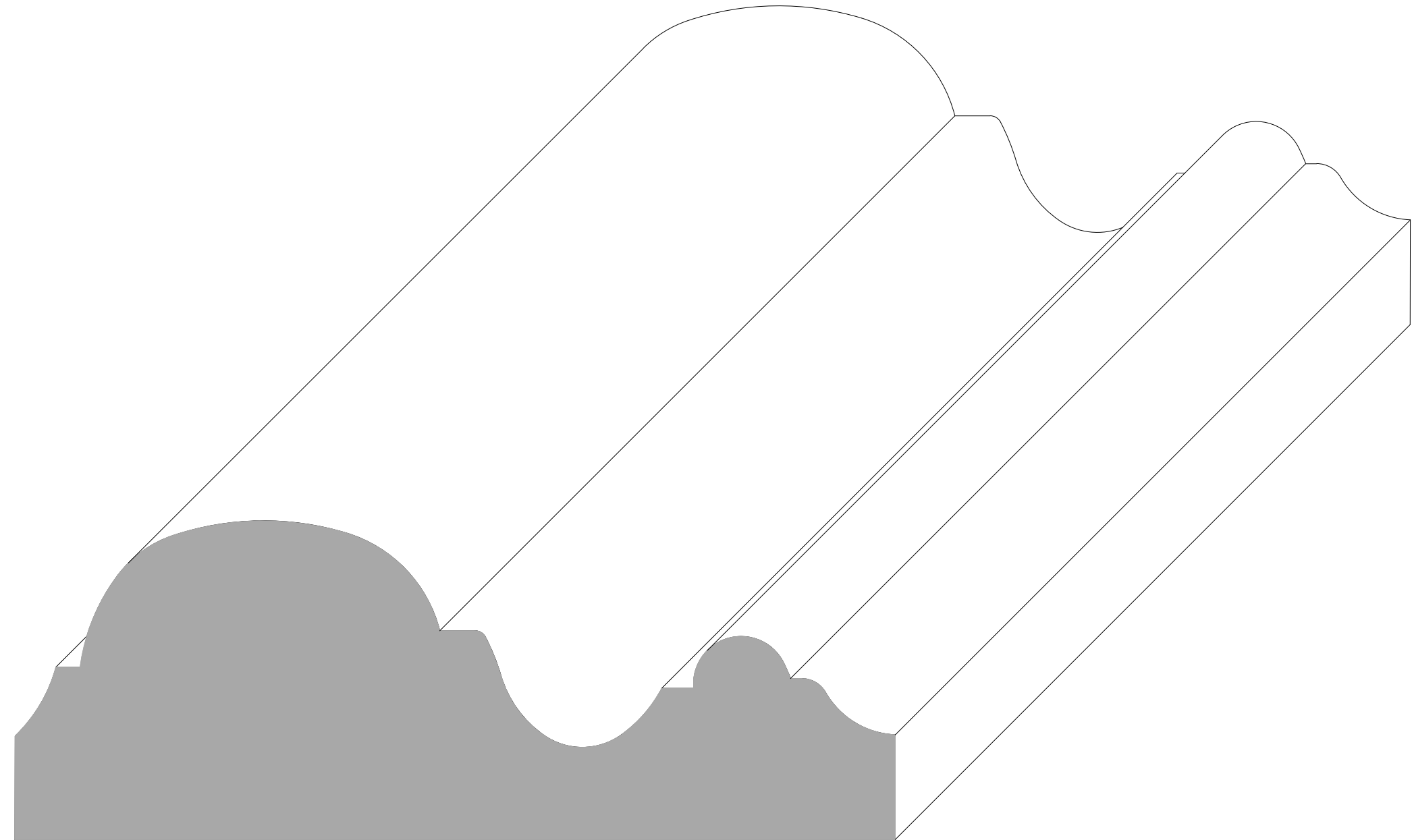

CH 3910 13/16 x 3-1/2

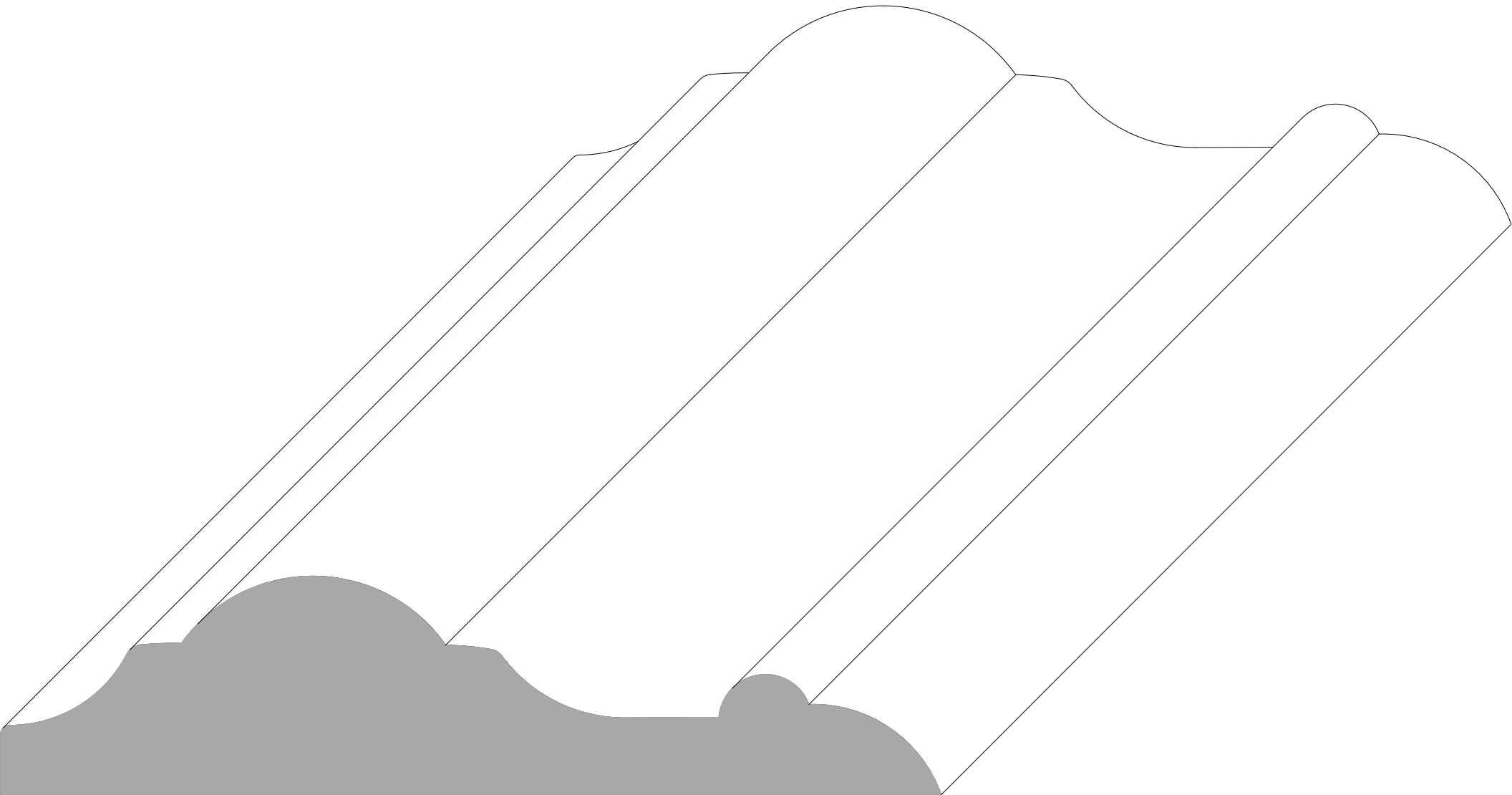

CH 4000 3/4 X 4

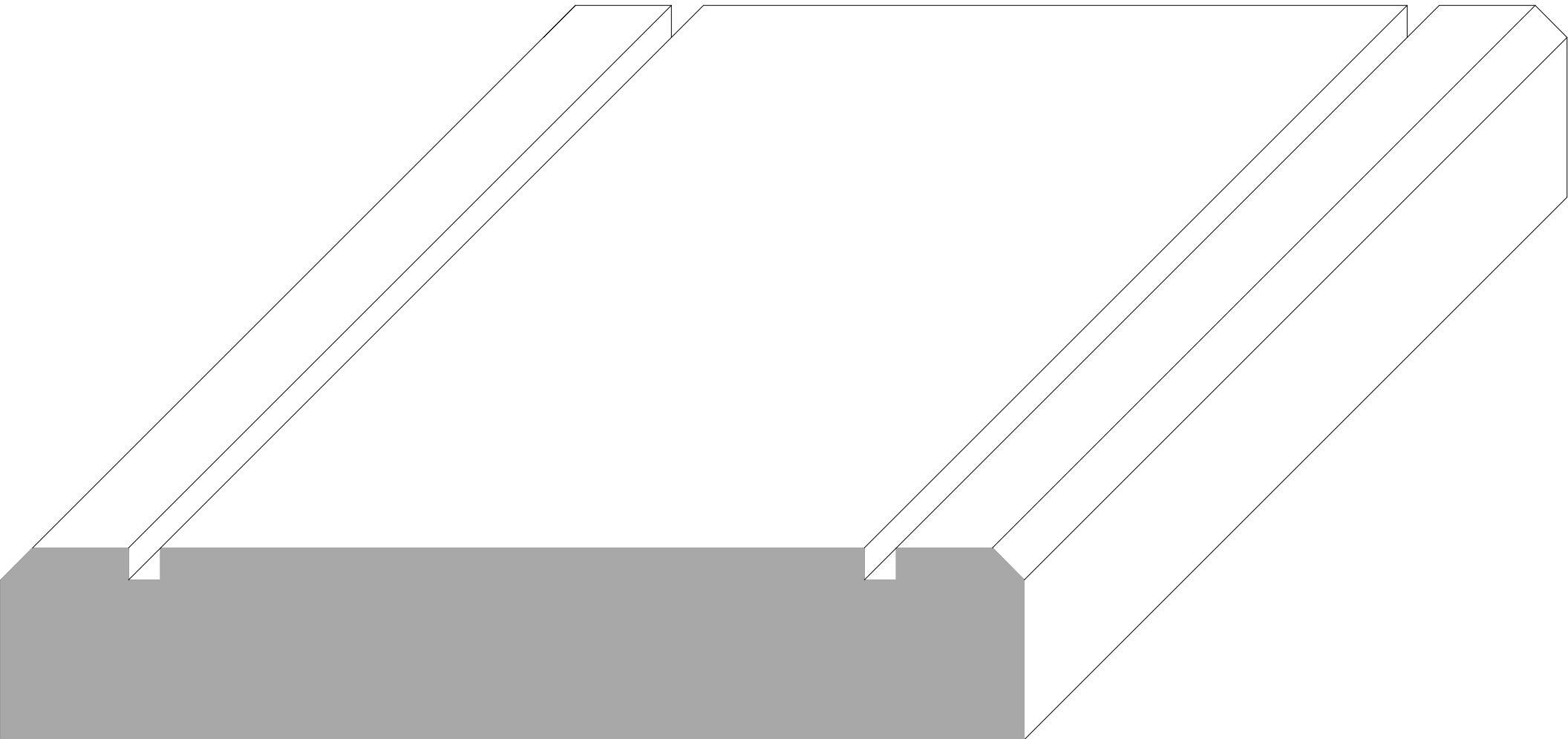

CH 4002 13/16 x 4

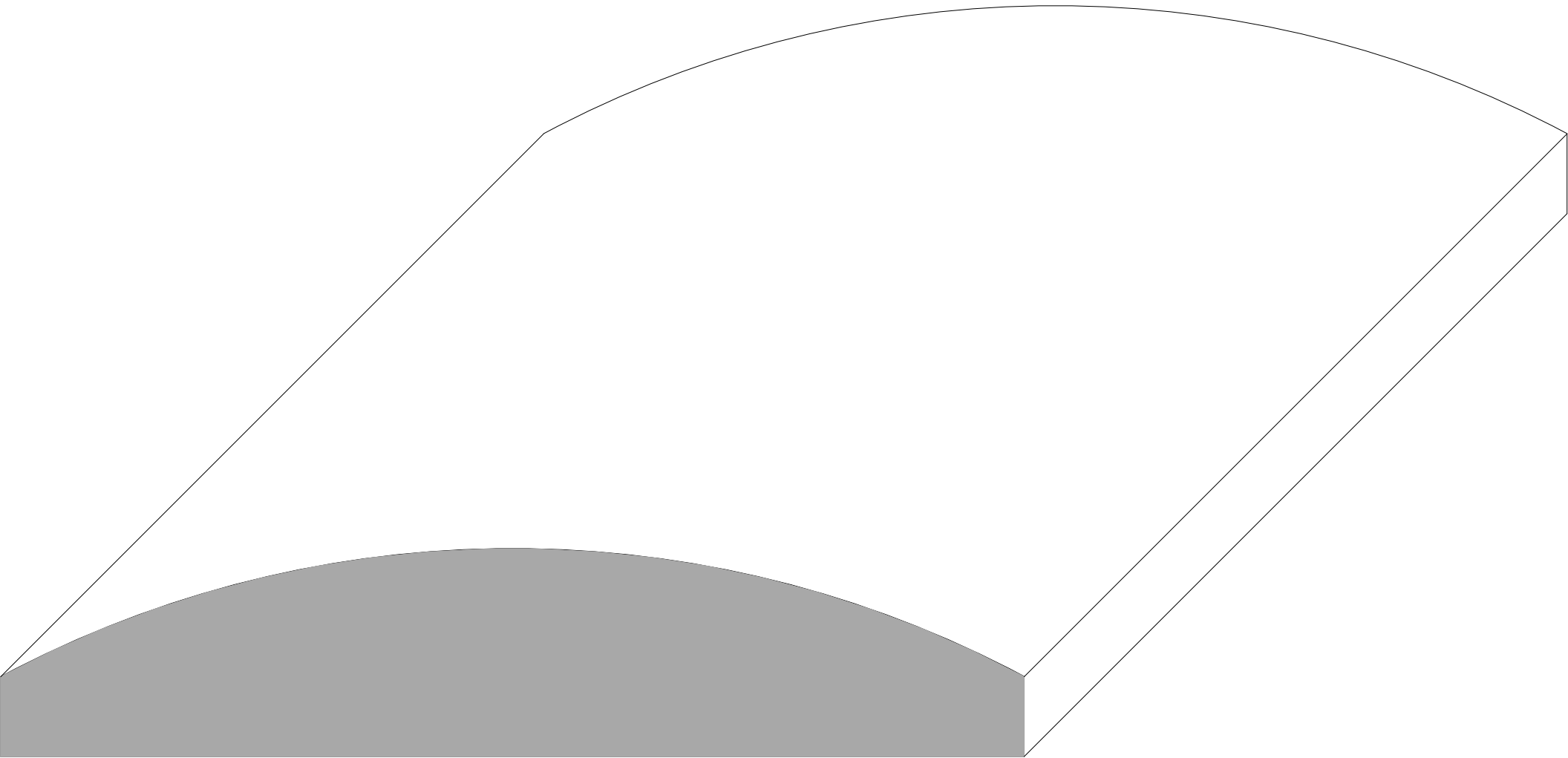

CH 4062 $5/8$ x $4-1/16$

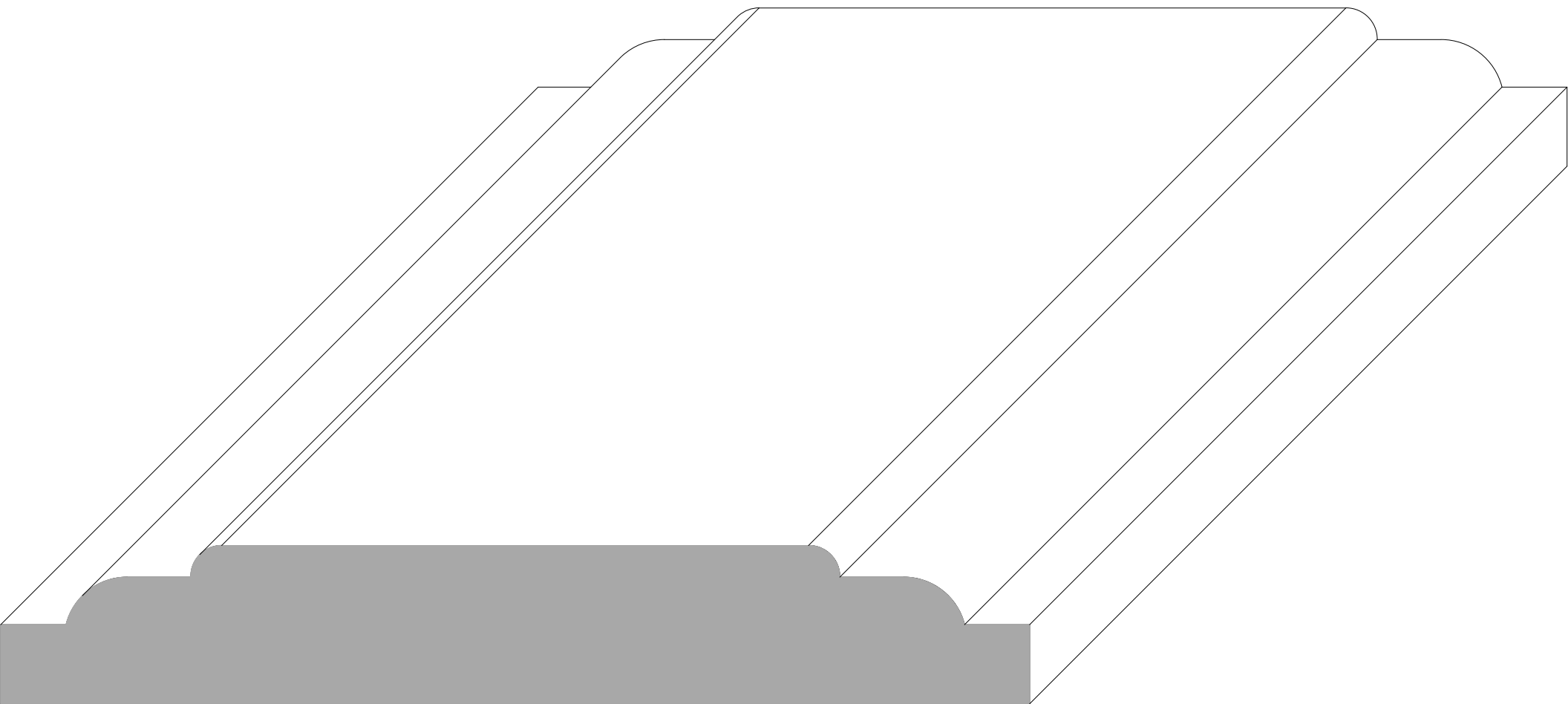

CH 4127 $3/4$ x $4-1/8$

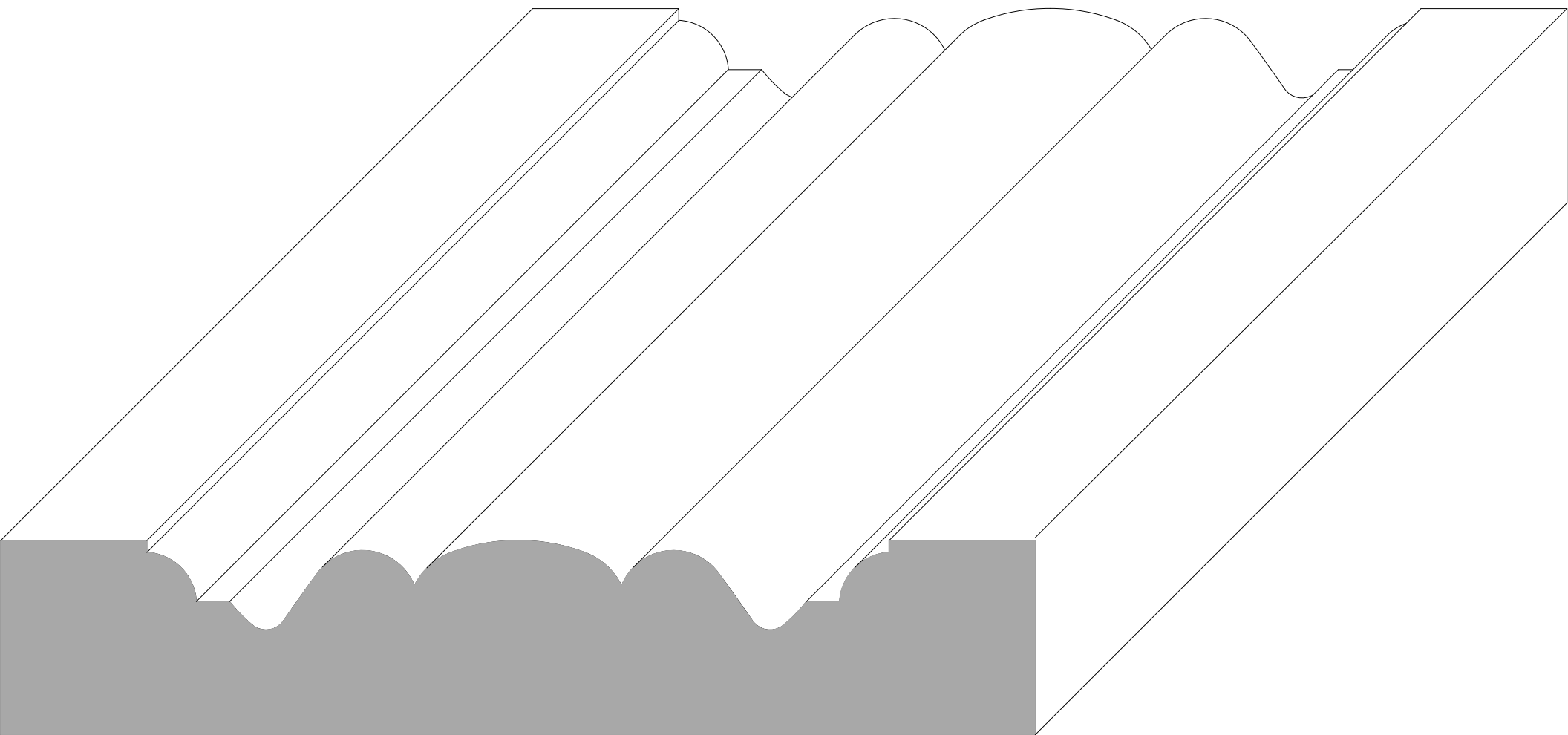

CH 4562 $1\frac{1}{16}$ x 4 $\frac{9}{16}$

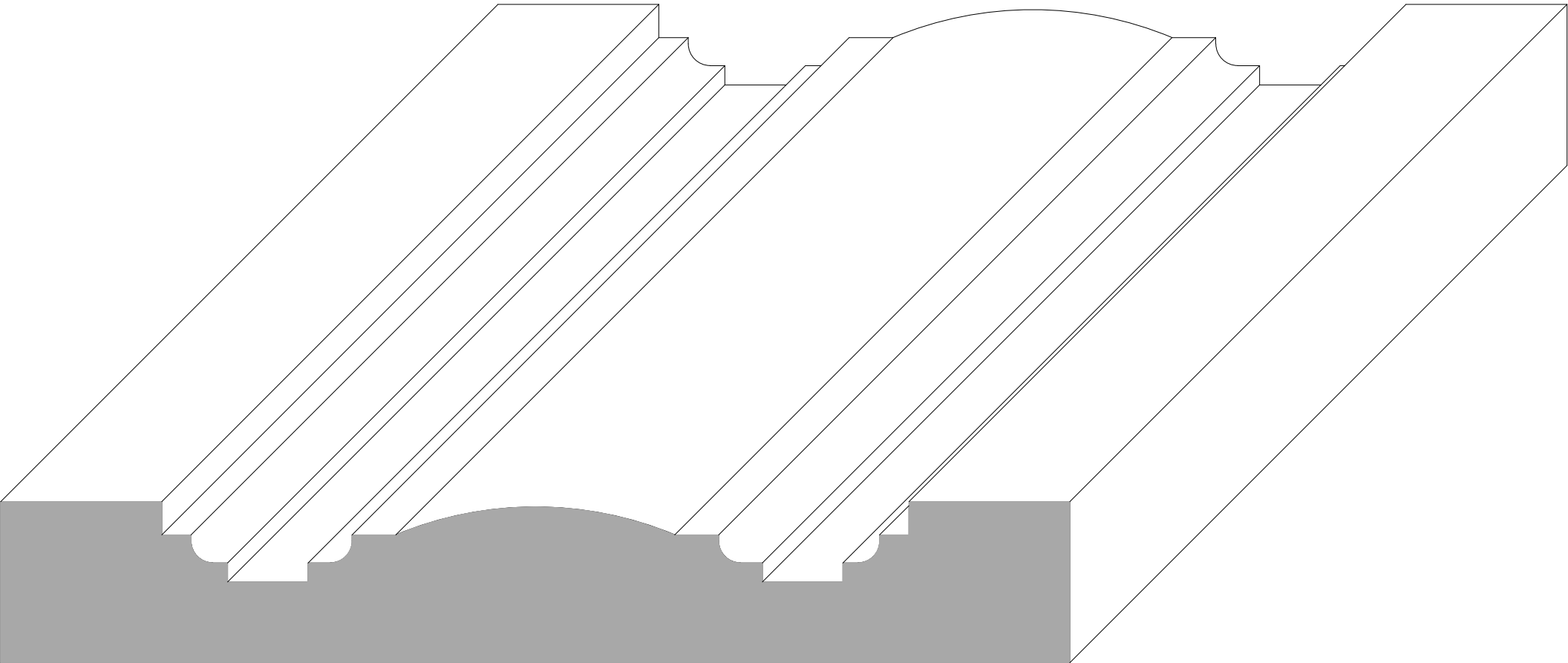

CH 4937 13/16 x 4-15/16

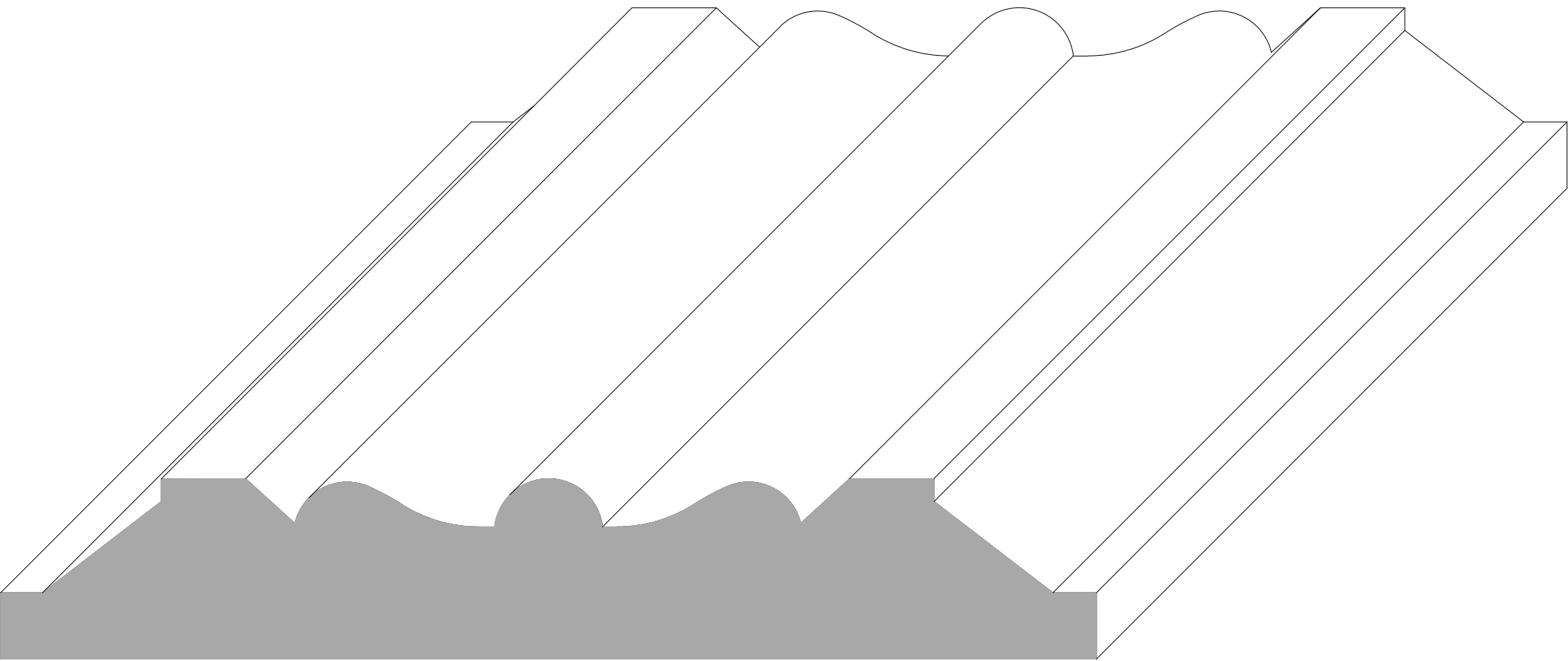

CH 5000 3/4 x 5

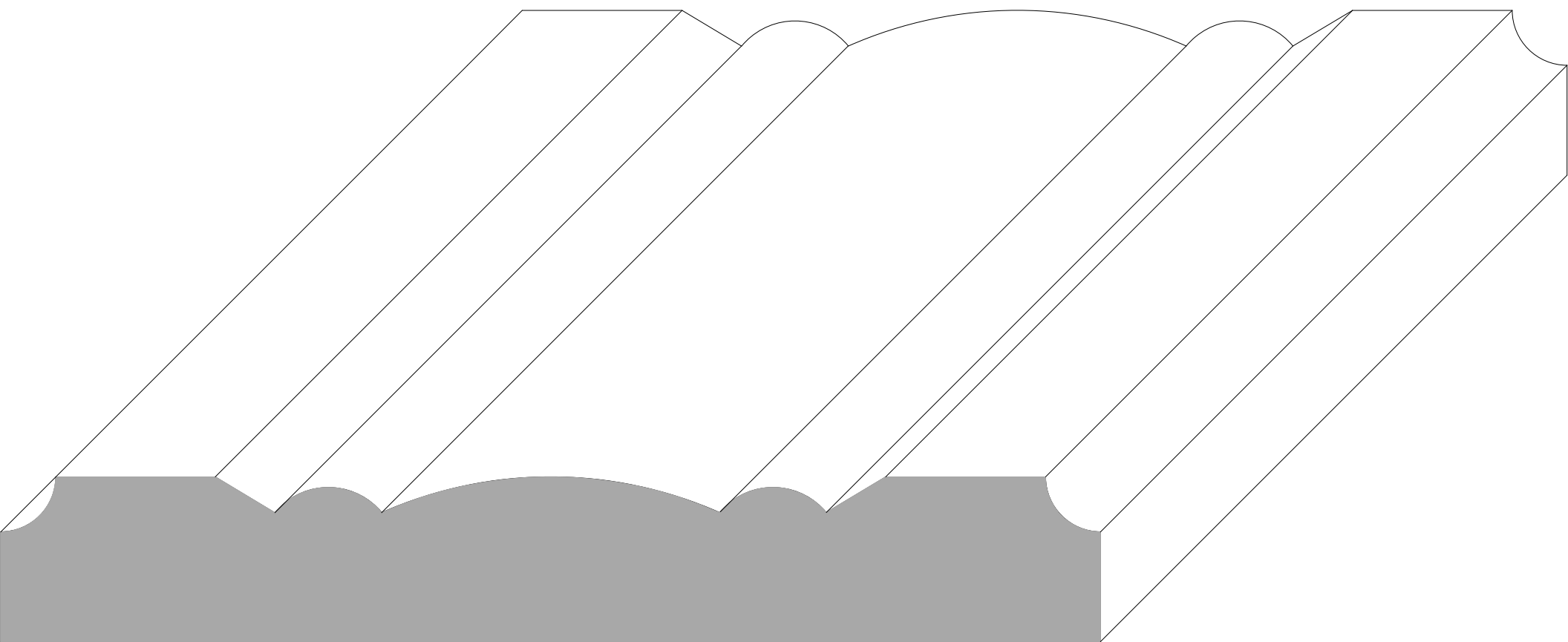

CH 5375 13/16 X 5 3/8

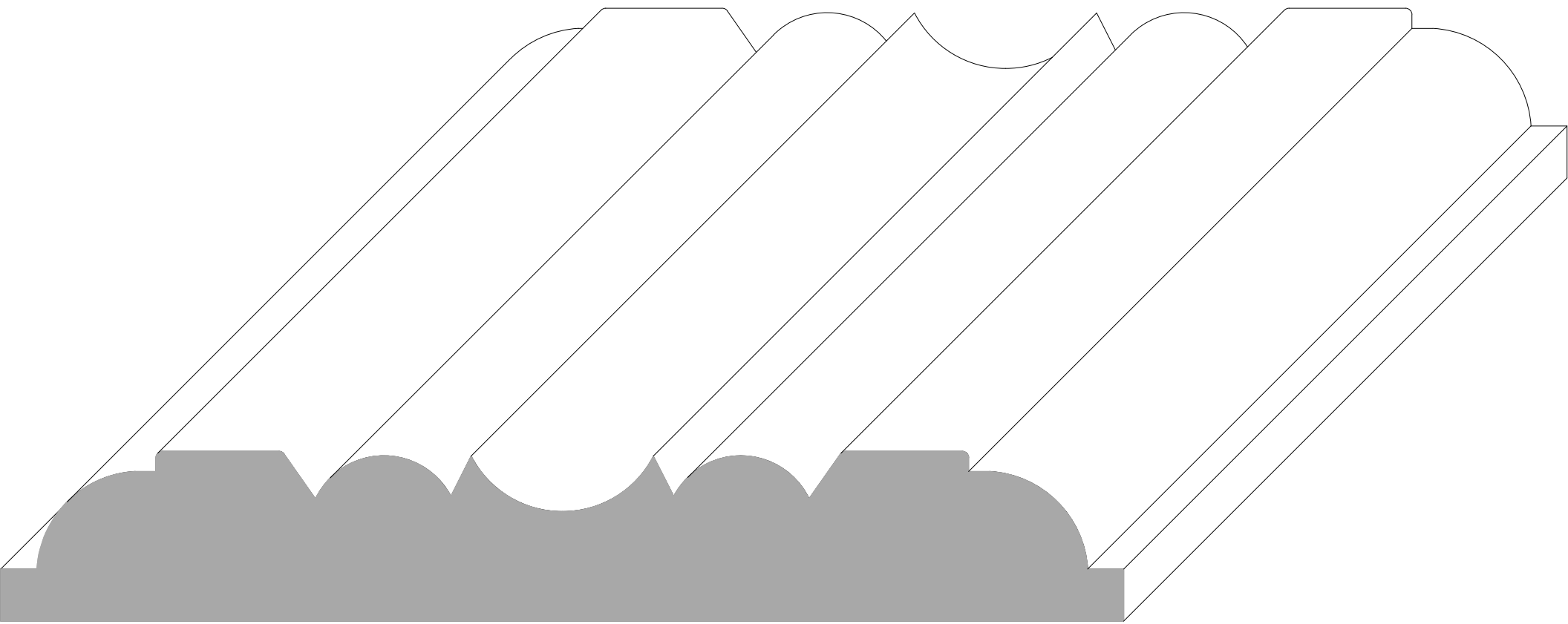

CH 5500 1 1/2 x 5 1/2

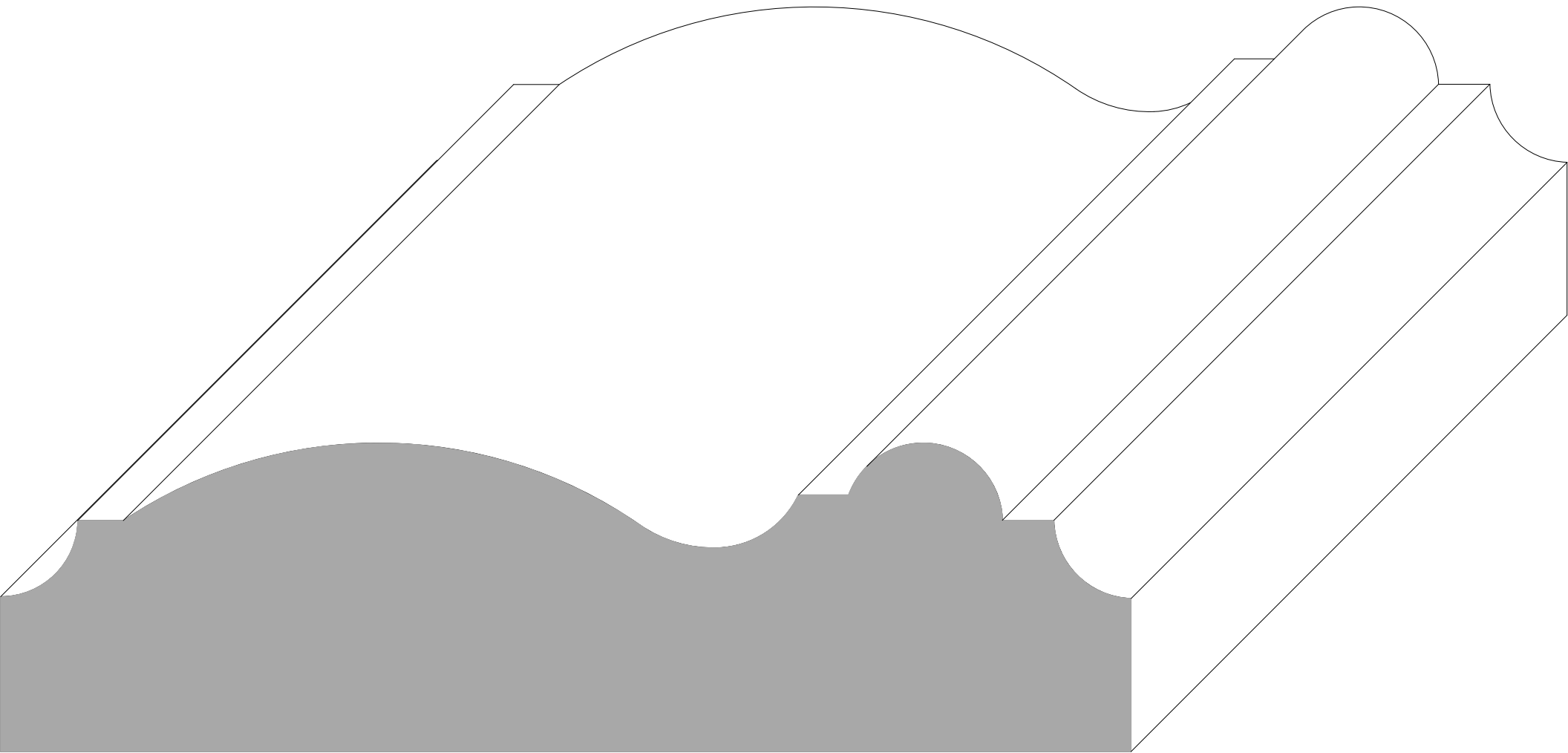

CH 6000 3/4 x 6

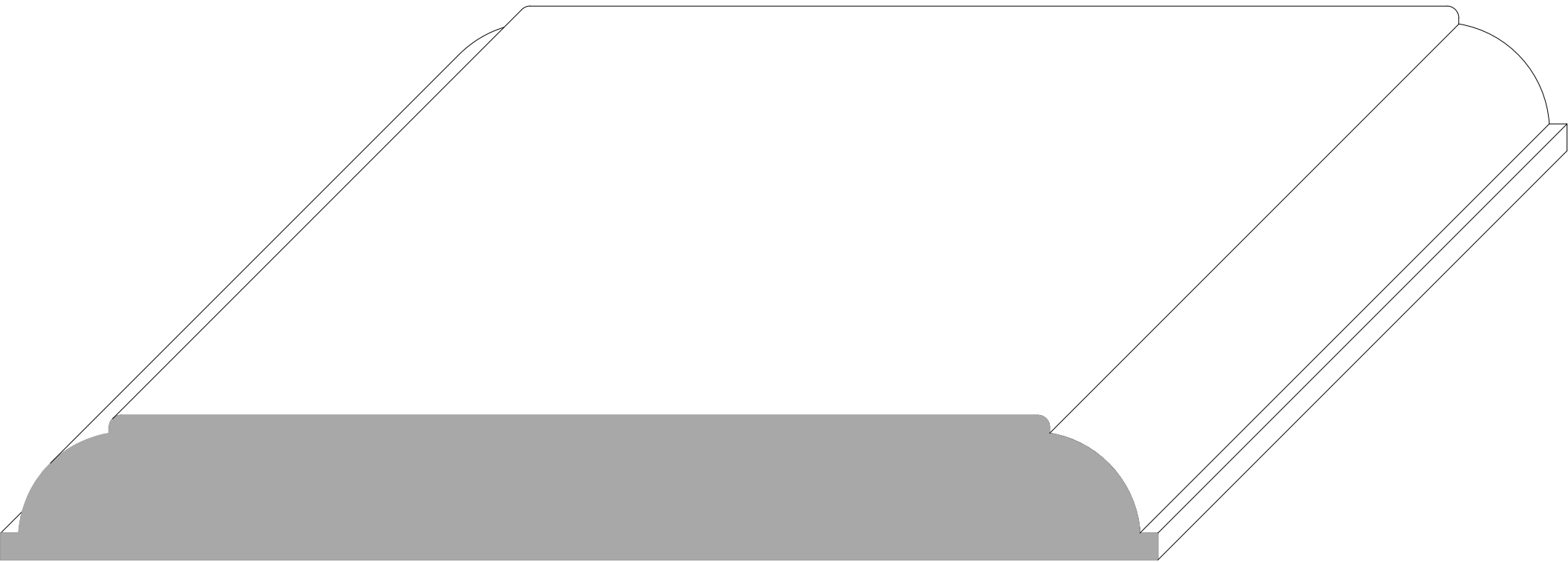

CH 6125 1 5/8 x 6 1/8

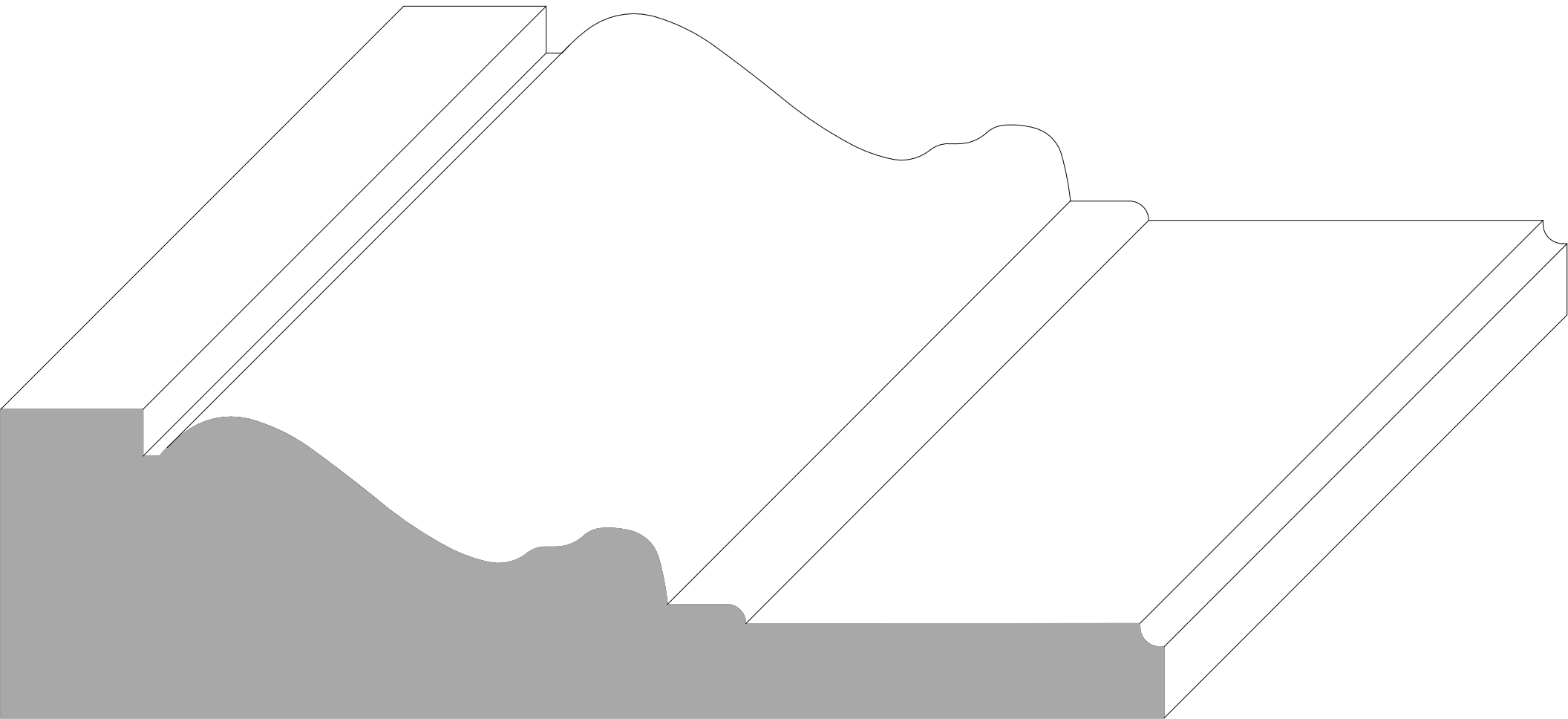

CH 7000 13/16 x 7

